

## WH LG XE4F-M Series

### Wall mounts for LG XE4F-M series

The outdoor screens of the LG XE4F-M series were developed for outdoor use. The special display is easy to see even in direct sunlight and always offers the viewer an optimal view to the content.

The wall mounting systems of the WH LG XE4F-M series were primarily developed for this special type of screens.

The specific mounting hole pattern of this wall mount has been adapted and optimized for the 49", and 55" version of the outdoor screen.

A hang out protection via theft-resistant screw ensures the necessary security.

The surface of the wall mount, which is made of stainless steel, is black as standard and finished with a corrosion-resistant plastic powder coating. This prevents corrosion and makes the wall mount highly weatherproof.

The screen can be mounted in landscape or portrait format.



installation in portrait or landscape format possible



hang out protection with theft-resistant screw

designed for:



## WH LG 49XE4F-M

### Display specific wall mount for LG 49XE4F-M

Item no.: 2504

- specific hole pattern for LG 49XE4F-M
- landscape or portrait installation possible
- incl. hang out protection with teft-resistant screw
- material: stainless steel, powder coated
- with corrosion-resistant plastic powder coating, highly weatherproof
- dimensions:  
width 1108 x height 576 x depth 114 mm
- colour: black

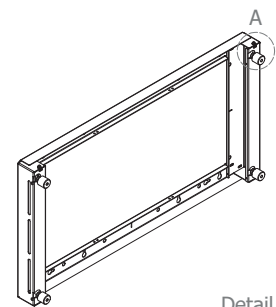
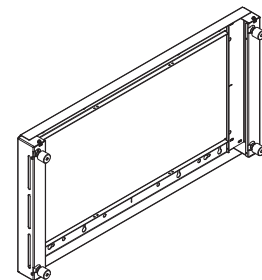
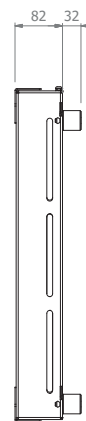
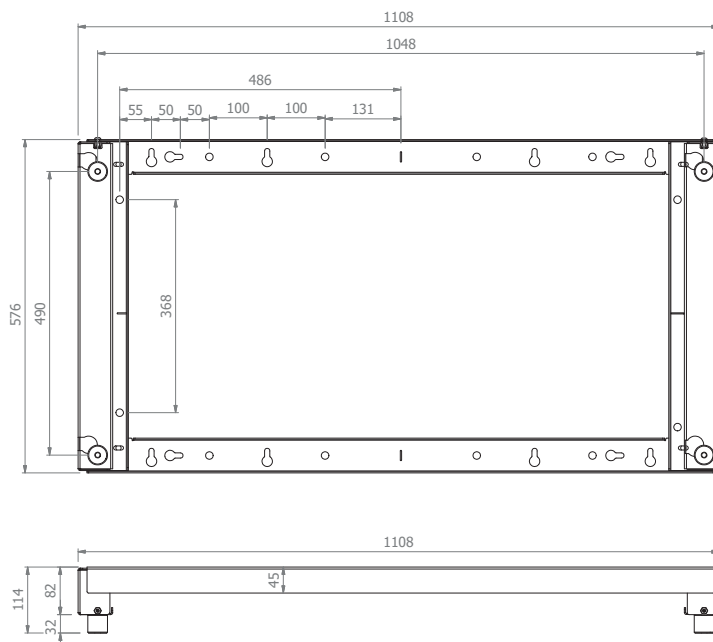

Detail A

SICHERUNGSSCHRAUBE  
ANTI-THEFT SCREWS

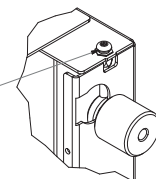

designed for:



## WH LG 55XE4F-M

### Display specific wall mount for LG 55XE4F-M

Item no.: 2514

- specific hole pattern for LG 55XE4F-M
  - landscape or portrait installation possible
  - incl. hang out protection with teft-resistant screw
  - material: stainless steel, powder coated
  - with corrosion-resistant plastic powder coating, highly weatherproof
- dimensions:  
width 1246 x height 635 x depth 114 mm
  - colour: black

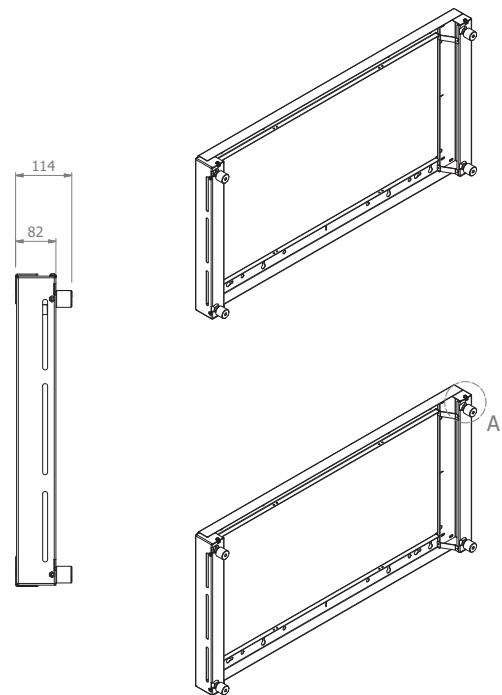
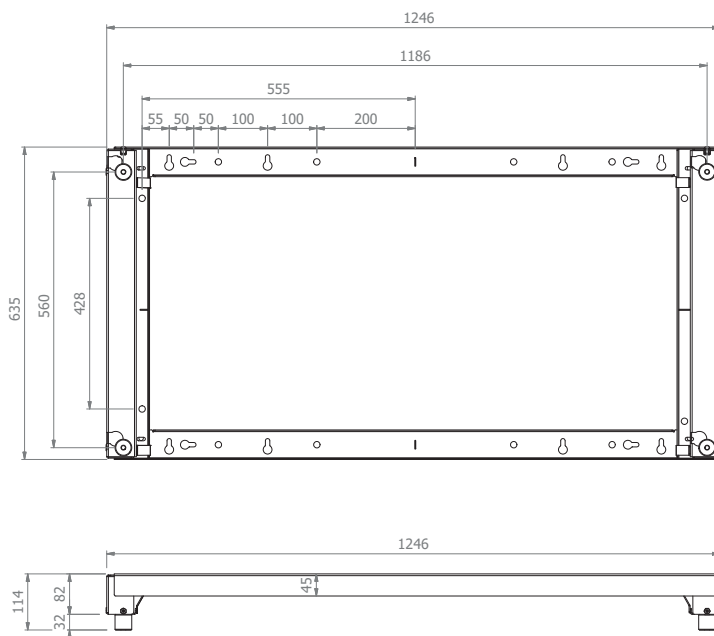

Detail A

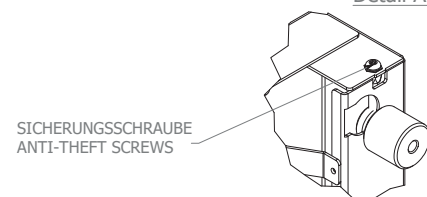

designed for:

